

1
2 THRU 19

2
3 THRU 18

5
6 THRU 11

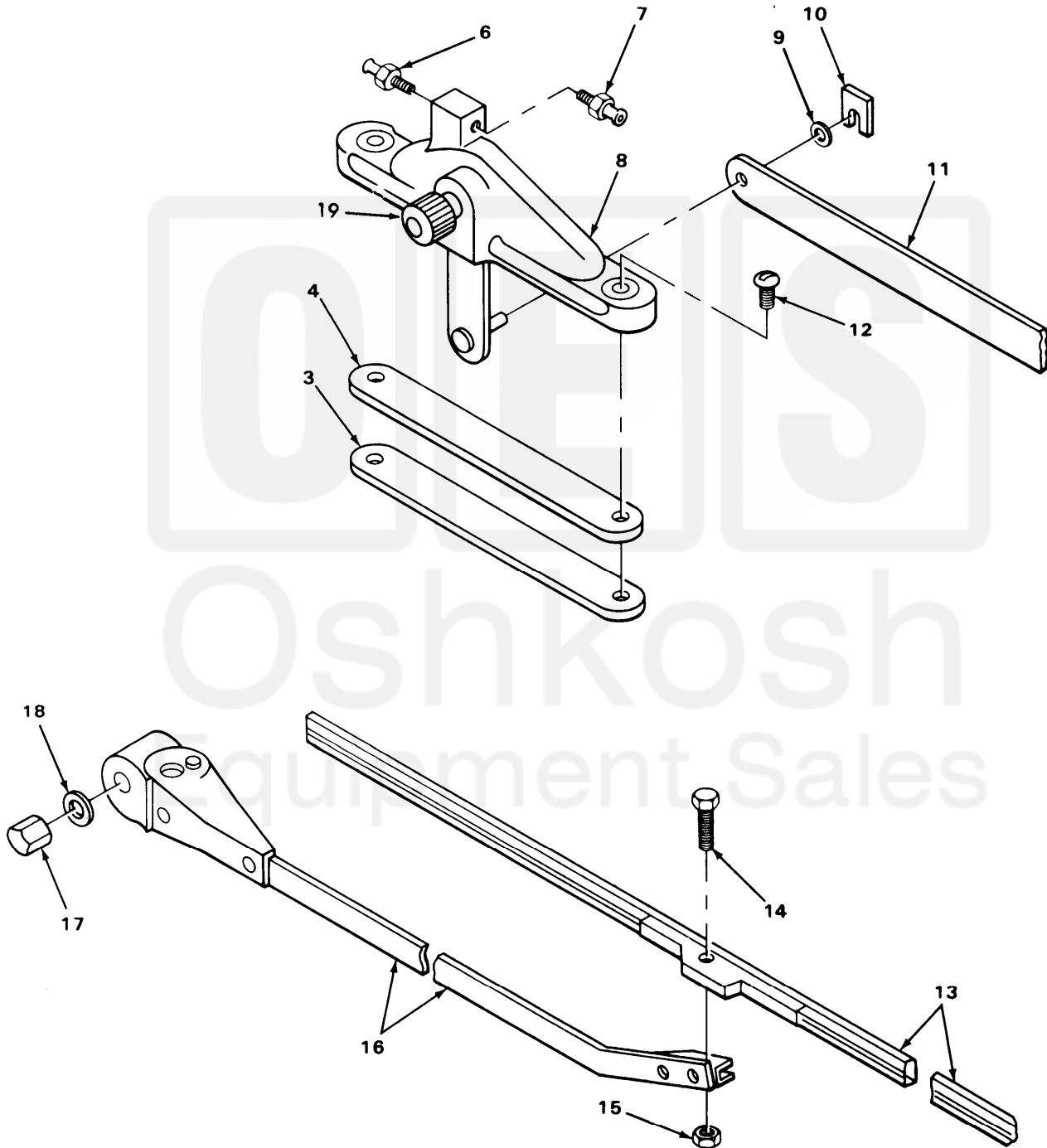

TA217210

FIGURE 279. WINDSHIELD WIPER ASSEMBLY.

Current part is item (4) on diagram. Available at www.oshkoshequipment.com

SECTION II (1)	ITEM (2)	(3)	TM9-2320-273-24P (4)	(5)	(6)
NO	CODE	FSCM	PART NUMBER	DESCRIPTION AND USABLE ON CODE (UOC)	QTY
				GROUP:22 CHASSIS AND HULL ACCESSORY ITEMS GROUP:2202 ACCESSORY ITEMS	
				FIGURE 279. WINDSHIELD WIPER ASSEMBLY.	
1	PAOOO	34623	5932051	ASSY,WASHER AND WIP	1
2	PAOOO	60703	9102-13	.WINDSHIELD WIPER	2
3	PBOZZ	60703	A86448J	..SPACER,PLATE	2
4	PBOZZ	60703	86447	..GASKET	2
5	PBOOO	34623	5731520	..PIVOT BODY ASSEMBLY AND CONNECTING ARM LH	1
5	PBOOO	60703	89142-121ZF	..PIVOT ASSEMBLY,WIND AND CONNECTING ARM RH	1
6	PAOZZ	60703	88171-4JD	...NOZZLE,WINDSHIELD UOC:U22,U23,U24,U25,U26	2
7	PAOZZ	60703	86022-4JD	...ADAPTER,STRAIGHT,TU	2
8	PAOZZ	60703	86446-2BC	...PIVOT,BODY	2
9	PBOZZ	60703	95000-37J	...WASHER,FLAT	2
10	PAOZZ	60703	78647-1J	...CLIP,SPRING TENSION	2
11	PFOZZ	60703	89340-284	...ARM,WINDSHIELD WIPE	1
11	PFOZZ	60703	89339-345	...CONNECTING LINK,RIG	1
12	PAOZZ	60703	86941-18JD	..SCREW,MACHINE	4
13	PAOZZ	34623	88600-47E	..BLADE,WINDSHIELD WI	1
14	PAOZZ	60703	NO.5-40X9/16	..SCREW,MACHINE	2
15	PAOZZ	60703	NO.5-40	..NUT,PLAIN,HEXAGON	2
16	PAOZZ	60703	90981-15BC	..ARM,WINDSHIELD WIPE LH	1
16	PAOZZ	60703	90982-15EC	..ARM,WINDSHIELD WIPE RH UOC:U22,U23,U24,U25,U26	1
17	PAOZZ	60703	75026-2ZF	..NUT,PLAIN,CAP	2
18	PAOZZ	60703	2397-J	..WASHER,LOCK	2
19	PAOZZ	60703	86324-13	..BUSHING,TAPERED	1

END OF FIGURE

Current part is item (4) on diagram. Available at www.oshkoshequipment.com